

IONIZATION SOLUTIONS

μWire AeroBar[®] System

5711-CTRL & Model 5711

User's Manual



ABOUT SIMCO-ION

Simco-Ion develops, manufactures and markets system solutions to manage electrostatic charge. As the world's largest provider of electrostatics management products and services, Simco-Ion improves its customers' business results by providing a total solution to their electrostatic challenges. Simco-Ion Technology Group is a division of Illinois Tool Works (ITW), located in Alameda, California. For more information about Simco-Ion visit www.simco-ion.com or call +1 800-367-2452. Simco-Ion is ISO 9001 Certified.

Ion Systems' logo  is a registered trademark of Simco-Ion, An ITW Company. © 2020 Ion Systems. Printed in the USA.

© 2020 Simco-Ion

TABLE OF CONTENTS

1. SAFETY WARNINGS	4
2. μWIRE AEROBAR SYSTEM	5
5711 AeroBar	5
AeroBar and Controller Identification.....	6
Bar Lengths	7
Air Jet Position	7
3. INSTALLATION	8
Mounting	8
End Brackets.....	10
Intermediate Brackets.....	10
Connection to 5711- CTRL Controller	12
Power Connection Options	13
Factory Monitoring System (FMS)	13
Gas Requirements	14
Gas Connections	14
4. OPERATION	16
Settings	16
Setup	16
Handheld Terminal (HHT)	18
Alarms	22
Standby	23
5. MAINTENANCE	24
Corona Wire Inspection and Cleaning	24
Cleaning the Corona Wire Cartridge Assembly & Chassis	25
Cartridge Insertion/Removal	26
6. SPECIFICATIONS	28
Dimension Drawings.....	29
Wiring Options.....	32
Parts & Accessories.....	33
WARRANTY & SERVICE	36

1. SAFETY WARNINGS

Carefully read the following safety information before installing or operating the equipment.

Failure to follow these safety warnings could result in damage to your ionization system and/or voiding the product warranty.

This instruction manual uses symbols to identify dangerous situations as follows:

GENERAL SAFETY

 **NOTE** – Statements identified with **NOTE** indicate precautions necessary to avoid potential equipment failure.

 **CAUTION** – Statements identified with **CAUTION** indicate potential safety hazards.

 **WARNING** – Statements identified with **WARNING** indicate potential serious injury hazards.

PRODUCT SAFETY

 **NOTE** – Do not attempt to operate at voltages other than those specified.

 **NOTE** – Do not allow dust, dirt or debris to block or obstruct air flow inlets or outlets.

 **NOTE** – This equipment must be correctly installed and properly maintained. Adhere to the following notes for safe installation and operation:

1. Read instruction manual before installing or operating equipment.
2. Only qualified service personnel are to perform installation and repairs.
3. All equipment must be properly grounded, including the machine frame to which the equipment is mounted.
4. Turn off input power to unit before connecting or disconnecting other equipment.
5. Do not operate the system in close proximity to fumes and flammable liquids.

 **CAUTION – Electric Shock Hazard**
Electrical installation and repairs must be performed by a skilled electrical engineer according to the applicable national and local regulations. The equipment must be properly grounded. Grounding is required to ensure safe and proper operation and to prevent electrical shocks upon contact.

 **WARNING – Fire Hazard**
Keep the unit dry. Do not operate the unit in flammable or explosive environments.

2. μ WIRE AEROBAR SYSTEM

The 5711 AeroBar uses patented μ Pulse technology to meet the performance, cleanliness and low cleaning/maintenance requirements of large surface areas, particularly those applications found in the flat panel display industry and assembly & testing of semiconductors.

This manual covers the installation, operation and maintenance of the 5711 AeroBar and 5711-CTRL controller.

There are two(2) components to the uWire AeroBar Model 5711 system:

1. The controller (5711-CTRL)
2. The AeroBar (5711-150 or 5711-250)

The Controller contains all the “intelligence” to run the system and interface with the Handheld Terminal; including IR, fault indicators (alarm LEDs) and FMS output all system parameters stored in the controller. The AeroBar contains the uWire power supply and monitors the wire for arcs and broken wire conditions.

5711 AeroBar

The 5711 AeroBar has the following unique features and benefits:

- Patented μ Pulse technology with a high-efficiency output
- Corona wire is utilized to provide a uniform ion distribution with low field voltage
- Low swing voltage permitting close placement to work surfaces
- μ Pulse technology and wire emitters combine to provide long maintenance cycles
- Air delivery system with straight air jets customizes the ionization to the specific application
- Short form factor (ionizer lengths of 150 mm and 250 mm)
- Remotely mounted 5711 Controller for easy access to Power Input, Status lights and FMS alarm connection

AeroBar and Controller Identification

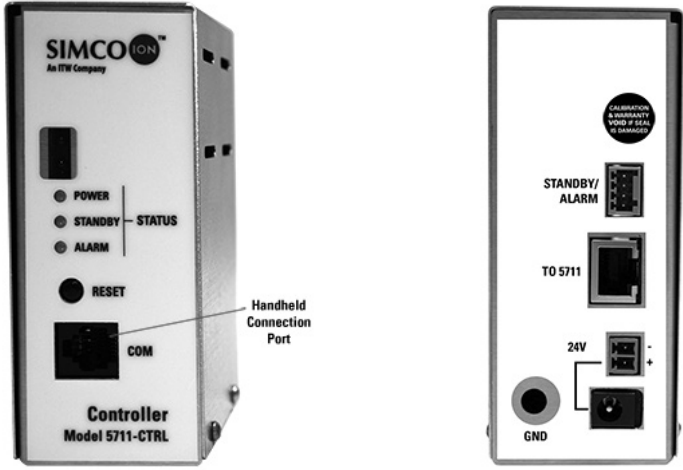
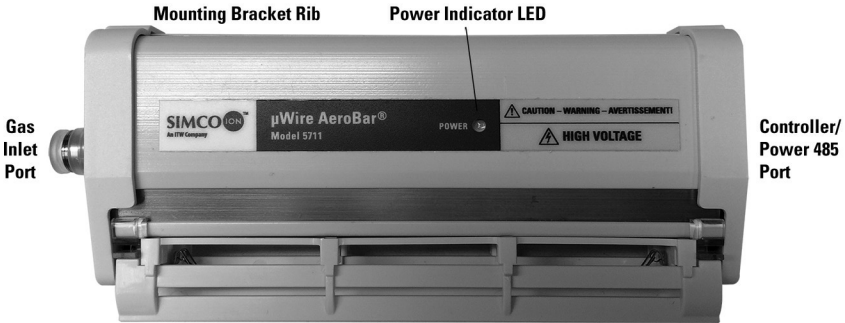
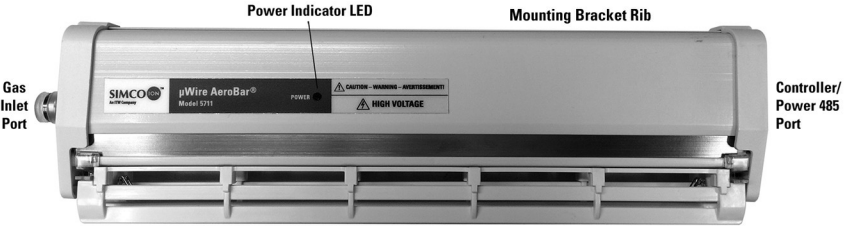

Figure 1. 5711-CTRL Controller (front and rear)



Corona Wire Cartridge

Figure 2. 5711-150 μWire Bar



Corona Wire Cartridge

Figure 3. 5711-250 μWire Bar

Bar Lengths

The 5711 AeroBar is available in two different lengths to fit tool environments with limited space.



NOTE – The 5711 AeroBar’s active length (L1) should be equal or greater than the length of the area to be ionized.

Bar Length	No. of 150 mm Cartridges	No. of 250 mm Cartridges	No. of Mounting Brackets
150	1	0	2
250	0	1	2

Table 1. 5711 AeroBar Length

There are two (2) 5711 AeroBar corona wire cartridges available; 150 mm and 250 mm. Both size cartridges share the same attributes, except length. The 5711-150 mm AeroBar will consist of only one (1) 150 mm cartridge. The 5711-250 mm AeroBar will consist of only one (1), 250 mm cartridge. Refer to Table 1 5711 AeroBar Lengths for cartridges types in any particular 5711 AeroBar length.

Air Jet Position

The 5711 AeroBar has straight air jets as standard. Straight air jets offer optimal performance directly underneath the bar.

Bar Length	No. of Air Jet with 25 mm Spacing
150	5
250	9

Table 2. 5711 AeroBar Air Jet Count

3. INSTALLATION

Keep in mind the following considerations when determining locations for the 5711 AeroBars:

- Observe all end-user site requirements and restrictions
- Optimal performance will be obtained in an environment with stable temperature and humidity levels
- Use proper mounting brackets and hardware as required by applicable building codes
- Avoid installing the 5711 AeroBar near moving components or surfaces
- Do not install the 5711 AeroBar in hazardous or explosive environments
- Do not install 5711 AeroBar closer than 150 mm (6 inches) to any ground or grounded painted surfaces; this will affect the performance of the ionizer
- Do not ground the 5711 AeroBar stainless steel side or end strips



CAUTION – Do not install 5711 AeroBar in close proximity (less than 150 mm (6”) to any grounded or grounded painted surfaces. Grounded surfaces closer than 150 mm will adversely affect the performance of the ionizer.

ATTENTION – Ne pas installer 5711 AeroBar à proximité (moins de 150 mm (6 ”) sur toutes les surfaces peintes à la terre ou à la masse. Surfaces Grounded plus proches de 150 mm sera affecter négativement les performances de l’ioniseur.

Mounting

The 5711 AeroBar has an integral rib molded along the top of its chassis. Mounting brackets can be securely clamped to this rib.



CAUTION – When mounting the bar from the end caps do not allow any connection between any mounting clips and the end cap reference clips. The end cap clips perform a critical function in the operation of the AeroBar and must not be connected to any external ground or circuit.

ATTENTION – Lors du montage de la barre de les bouchons d’extrémité n’ont pas de connexion aux clips de référence. Ces clips exécutent une fonction critique dans l’opération de l’AeroBar et ne doivent être raccordés à aucune terre externe ou à circuit.

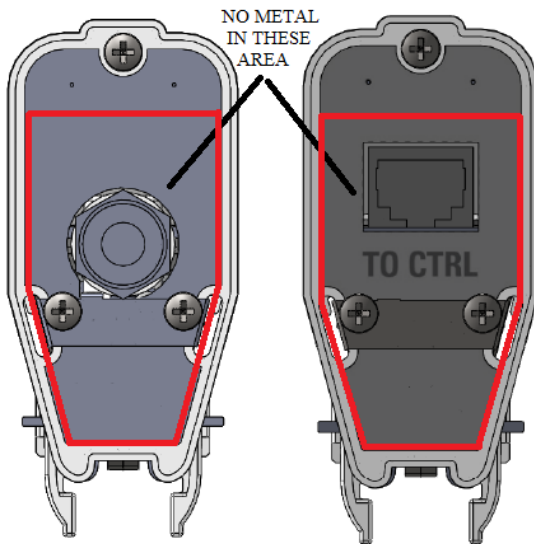

Figure 4. 5711-150 mm AeroBar End Cap

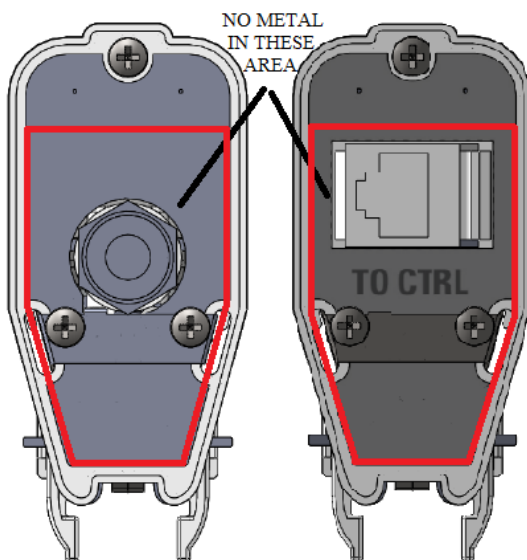
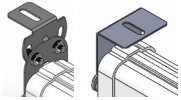
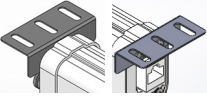
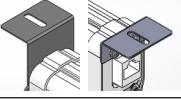
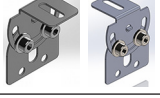
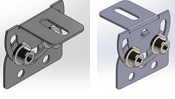

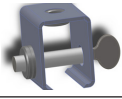
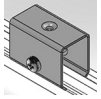
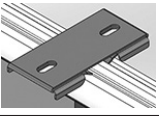

Figure 5. 5711-250 mm AeroBar End

Specially designed stainless steel mounting brackets are available for the 5711 AeroBar and can be ordered from Simco-Ion. The following table shows the available brackets for use with the 5711 AeroBar.

End Brackets

Part No.	Brackets	Mounting		Size	
		Fixed	Rotatable	Standard	Low Profile
32-2501-01 4.4 mm single slot (can be inverted)		●		●	
32-2503-01 4.4 mm triple slot (can be inverted)		●			●
32-2502-01 4.4 mm single slot		●			●
32-2511-01 4.4 mm single slot (can be inverted)			●	●	
32-2510-01 4.4 mm single slot (can be inverted)			●		●

Intermediate Brackets

Part No.	Brackets	Mounting		Size	
		Fixed	Rotatable	Standard	Low Profile
32-2213 8-32 thread		●		●	
32-2500-01 M3 thread (increase width to 1"/2.54 cm)		●		●	
32-2504-01 4.4 mm double slots (increase width to 1"/2.54 cm)		●			●
32-2211-01			●	●	



CAUTION – To avoid injury to one’s self or the product, all mounting clips and brackets must be connected to a low-impedance earth ground.

ATTENTION – Pour éviter les blessures à soi-même ou le produit, tous les clips de fixation et les supports doivent être connectés à un la terre à basse impédance.

Mounting brackets should be equally spaced along the length of the bar. A minimum of two mounting brackets is recommended for each 5711 bar. All end mounting brackets are orderable in a kit of two and include mounting screws (pan head self-tapping SST 6x19, 3/8th inch).

The 5711-CTRL controller can be mounted to any fixed flat surface by using the optional controller mounting brackets (part number 32-5713-01). Two (2) mounting brackets are required. Attach each mounting bracket to 5711-CTRL by loosening the screws on each side of the controller chassis, attaching the bracket and re-tightening the screws.

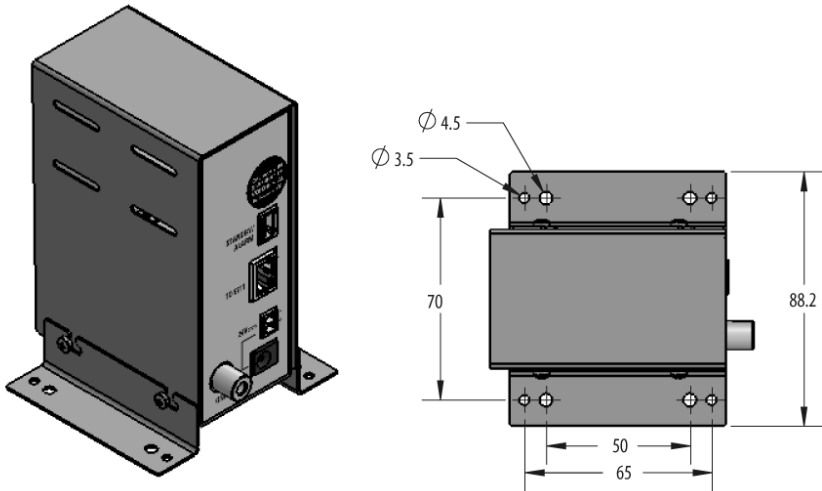

Figure 6. 5711-CTRL with Mounting Brackets (side view & bottom view)

Connection to 5711- CTRL Controller

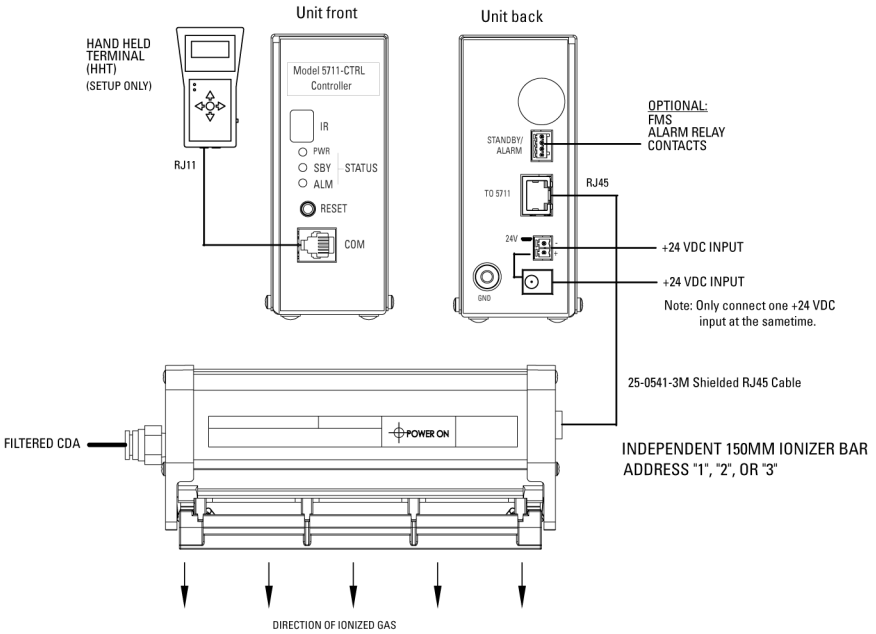

Figure 7. 571-CTRL Controller and 5711-150 mm Bar Wiring Setup

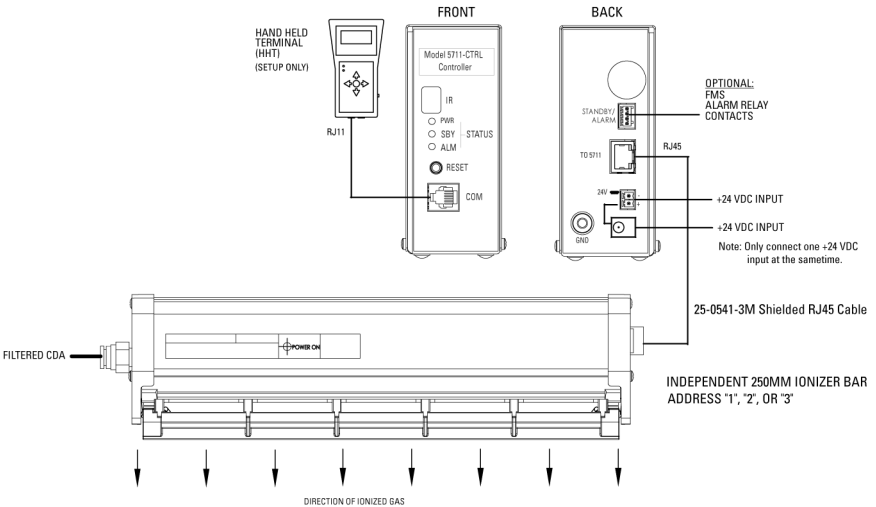

Figure 8. 5711-CTRL Controller and 5711-250 mm Bar Wiring Setup

Power Connection Options

Primary electrical power input connection to the 5711-CTRL Controller is made through the two-pin terminal block connector or the DC barrel jack on the rear panel of the 5711 controller that is labeled “24 VDC”. Please connect the input voltage to only one of these connectors. Do not connect power to both of these connectors at the same time. The +24 VDC power to the 5711-CTRL Controller can be supplied by either the end-user’s tool power or by an external DC power supply. An appropriate external power supply can be ordered directly from Simco-Ion (P/N #14-21328). If the end user chooses to supply their own external DC power supply, it should be a UL Listed ITE power supply that has a “LPS” or “Limited Power Source” marking.

The 5711-CTRL Controller requires +24 VDC \pm 10%, 12W max.

Terminal Block		DC Jack Barrel (center pin positive)	
PIN	Description	PIN	Description
1	24 VDC Input		24 VDC Input
2	Power Ground		

Table 3. Terminal Block 2 Pins Power Connectors and DC Jack Barrel Power Connector (24 VDC POWER)

Factory Monitoring System (FMS)

The 5711 controller provides for an Alarm relay contact and a Standby input.

The alarm relay contacts are across pins 2 and 3 of the 5711 controller “STANDBY/ALARM “ terminal block 4 pin connector. The relay contact is open when the 5711 AeroBar is either not powered or is in an alarm state (see Table 5. 5711 AeroBar Alarm Codes for more information). The alarm relay contact is rated for +/-24 VDC @ 0.2A maximum.

The standby input, pin 4 (active low), allows the user to temporarily stop the ion production without turning off the 5711 AeroBar. This is most useful when the ionization needs to stop when there is no product under the 5711 AeroBar, thus extending the maintenance interval on the 5711 AeroBar. Standby is activated by pulling pin 4 of the “STANDBY/ALARM” 4 pin connector low. See Chapter 3 for more information about Standby mode.

Pin	Description
1	Ground
2	Alarm A
3	Alarm B
4	Stand-by In

Table 4. 5711 AeroBar’s “STANDBY/ALARM” MOLEX 4 Pins Connector

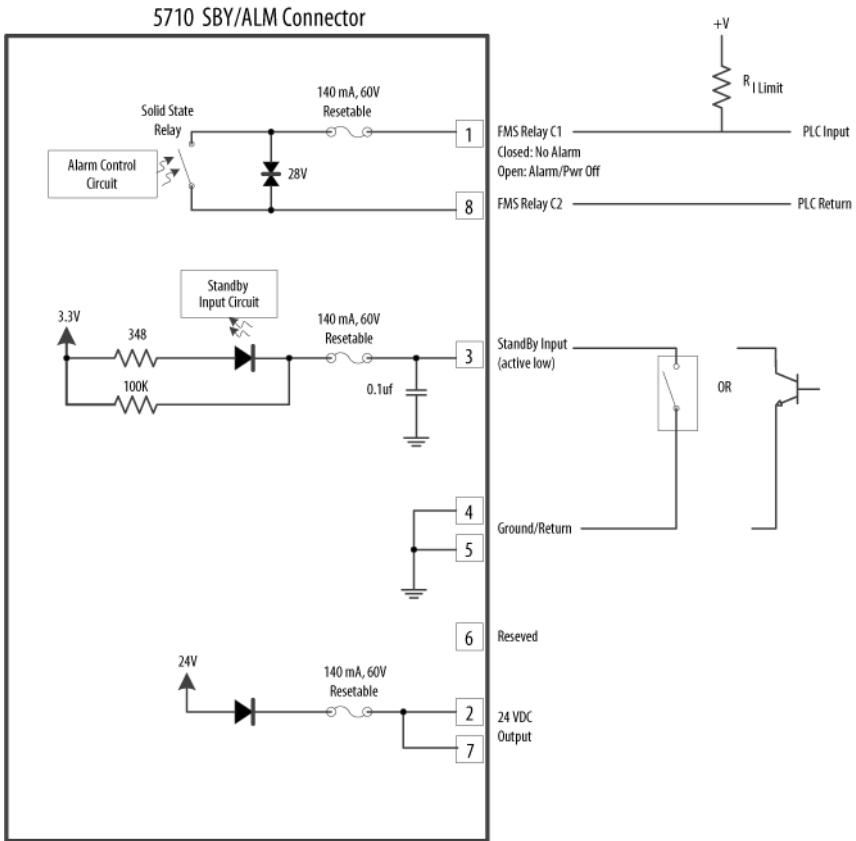

Figure 9. 5711 Wiring Diagram

Gas Requirements

A flow meter is recommended for use in conjunction with gas input to the 5711 AeroBar. The use of a flow meter will help to establish a defined and uniform flow of air through the ionizer.

Simco-Ion strongly recommends using clean dry air (CDA) to improve performance of ion delivery to the target. A CDA supply should be appropriately filtered to remove moisture, oil, and particles. Filtration to the end user's desired cleanliness level is recommended (filtration systems are not supplied by Simco-Ion.) Using the 5711 without CDA will adversely affect decay times.

Gas Connections

The 5711 AeroBars have a quick push-connect gas inlet fitting that mates with 6 mm O.D. tubing on one end of the bar.

To connect the air supply tubing to the 5711 AeroBar:

- Insert the tubing into the gas quick fitting on the endcap. Be sure the tubing is fully inserted by gently tugging back on the tubing to lock the tube into place.
- To remove the tubing from the fitting, push in the fitting collar towards the bar to release the tubing.

The amount of CDA required will be a function of many factors, including the presence of airflow from HEPA filters, decay time and swing voltage requirements, and distance from the bar to the product. Simco-Ion recommends a minimum of at least 10 liters/ minute flow for each 150 mm grill assembly on the bar and 18 liters/ minute flow for each 250 mm grill assembly on the bar. This is to provide about 2 lpm of gas flow per jet orifice. For example:

5711-150 mm = 10 liters/minute (total flow per bar)

5711-250 mm = 18 liters/minute

More CDA than this may be necessary to meet a specific application performance requirement. See Chapter 3 for more information on the trade-off between CDA airflow and bar performance.

4. OPERATION

Settings

The 5711 AeroBar comes from the factory with default settings that can be optimized for a particular application. For best performance, the settings should be tuned for your specific application--size of the target, distance to the target, purging airflow, HEPA airflow, etc.

There are only four settings that need to be adjusted to optimize the 5711 AeroBar's performance in your environment: Frequency, Positive Power, Negative Power and Balance:

- **Frequency:** Sets the rate of positive and negative ions being supplied to the target. A lower frequency will increase the swing voltage present on the target. Conversely, a higher frequency will decrease the swing voltage present on the target. Typically, a lower frequency will reduce decay time as measured on a CPM.
- **Positive Power:** Sets the amount of positive ions produced. Increasing the Positive power level will produce more positive ions, shift the ion balance in the positive direction and will reduce the negative decay time.
- **Negative Power:** Sets the amount of negative ions produced. Increasing the Negative power level will produce more negative ions, shift the ion balance in the negative direction and will reduce the positive decay time.
- **Balance:** Sets the ratio of positive and negative ions produced for each cycle. Adjust the Balance value to coarsely adjust the ion balance at the target. Then, use the Positive Power and/or Negative Power settings to fine-tune the ion balance at the target.

Setup

The 5711 AeroBar is designed for easy setup and calibration. In order to obtain the optimum performance for your environment, perform an initial setup with a charged plate monitor (CPM) positioned at the targeted area under the ionizer. The Simco-Ion Model 280A CPM is recommended.

Below is a list of guidelines to keep in mind when setting up the 5711 AeroBar:

- Lower the frequency and increase the voltage levels to reduce ion recombination prior to the ions reaching the target.
- For small target areas that are close to the AeroBar (typically within 50-150 mm to the bar), lower the \pm power levels to reduce the ion emission and use a higher frequency setting to decrease the swing voltage.
- For long-distance applications, a setup with lower frequencies is appropriate.
- For short-distance applications, a setup with higher frequencies is appropriate.

- Adjust the balance to ensure that equal numbers of positive and negative ions reach the target area
- Balance can be “fine-tuned” by using the Positive and Negative Power setting.

Example of a Typical Setup

1. The 5711 AeroBar is a single bar system. The default address 1 (independent) is sufficient to fully operate the AeroBar.
2. Securely mount the bar (see Chapter 2). Place a Charged Plate Monitor (CPM) at the actual target location for the ionized air stream.
3. Connect filtered CDA to the bar. (see Chapter 2)
4. Connect power to the bar. (see Chapter 2)



CAUTION – The Model 5711 bar will be powered up as soon as it connects to a powered 5711-CTRL controller through an RJ-45 cable.

ATTENTION – Le modèle 5711 bar sera mis sous tension dès que alimentation 24 VCC est raccordé à la barre.



NOTE – Use either a wired connection to a Handheld Terminal (HHT) or IR communication from a battery-powered HHT to adjust the bar’s operating parameters.

5. Set the operating Frequency. Select the Frequency based on the maximum +/- swing allowed at the target area. Set the Frequency at the value that provides a +/- swing that is as close as possible to the maximum limit allowed by the end user’s specifications, but without exceeding the limit.
6. Set both the Positive and Negative Power settings for a starting value somewhere between 50-55%.
7. Use the Pulse Balance screen of the HHT to adjust the Pulse Balance value either more (+) or (-) to center the +/- swing around zero.
8. If necessary, use the Positive Power and Negative Power adjustments to increase or decrease the peak amount of +/- swing.
9. If needed, adjust the Pulse Balance again to re-center the +/- swing around zero.



NOTE – Disconnecting the 5711 AeroBar from the 5711-CTRL Controller, while the system is powered up will cause a latched alarm condition (Alarm Code 9 - Broken Wire Detected). To clear this alarm, re-connect the 5711 AeroBar to the powered Controller and either press/release the “Reset” button on the front panel of the Controller or cycle the 24 VDC input power to the system OFF and then back ON again.

The general performance of the 5711 AeroBar will be determined by a number of factors:

- The bar's adjustable operating parameters set by the end-user
- The CDA flow rate through the ionizer. A higher CDA flow rate generally means a faster CPM decay at the target.
- Any HEPA airflow rate in the target environment. Higher environmental airflow from the bar to the target area generally results in a faster CPM decay rate at the target.
- The proximity of nearby grounds. Grounded surfaces near the ionizer or in the ionized air stream can cause shifts in the balance and/or slower decay times.
- The maintenance level of the bar's corona wire system. A poorly maintained ionizer will result in reduced ionizer performance for both decay times and balance.

Handheld Terminal (HHT)

Use the Handheld Terminal (HHT) to change the settings of the 5711 AeroBar. The HHT can be used to monitor the 5711 AeroBar during operation (It is recommended that the HHT be removed from the system after setup to prevent inadvertent changes to the operating parameters.)



The HHT has an LCD display, two LED indicators, 5 menu navigation buttons, an IR (infrared) Communications interface, two RJ-11 ports, and a Power On/Off switch:

- **LCD Display** is where the setting and 5711 AeroBar information is displayed
- **COM/STATUS** (Green) displays the current HHT and Bar Status
 - A flashing indicator indicates the HHT is communicating to the 5711 AeroBar
 - A solid on indicator indicates the bar is on and ionizing

Fault (Red) displays fault at either the HHT or 5711 AeroBar:

- A flashing indicator indicates that the 5711 AeroBar and HHT are not communicating
- A solid on indicator indicates the 5711 AeroBar is in alarm or standby and may not be ionizing. Some alarm states still allow the bar to operate; see Table 5 Alarm Codes, for more information

Menu Navigation buttons allow the user to view or set 5711 AeroBar parameter:

- **<UP>/<Down>** Arrows increment or decrement the parameter value
- **<LEFT>/<RIGHT>** Arrows navigate to screens menus
- **<ENTER>** sends the parameter value shown on the "NEW" line to the bar or performs the requested act

SIMCO ION
MICROWIRE 5700
VERSION x.x
IR MODE

IR (infrared) Communications interface allows two way line-of-sight communications to the 5711 AeroBar. A 9 VDC battery (internal) is required for using the IR interface. When the HHT is turned on and not wired to the 5711 AeroBar, it will automatically switch to IR mode. The IR range is approximately 8 feet.



NOTE – In IR Mode, the HHT does not update automatically. To refresh the screen, point the HHT at the 5711-CTRL controller and press the <ENTER> key. In wired Mode, the HHT updates automatically.

SIMCO ION
MICROWIRE 5700
VERSION x.x

Two RJ-11 ports on the bottom of the HHT allow for power and communication connections to a 5711C Controller over a wired RS-485 balanced pair serial interface.

Power ON/OFF switch allows the user to turn on or off the HHT. In the IR mode it is best to turn off the HHT when not in use to conserve battery power.

BAR ADDRESS shows or sets the 5711 AeroBar’s communication address. To set a bar’s operating parameters, the HHT needs to be set to the desired 5711 AeroBar’s address.

- Press the <Up> or <Down> Arrow to select a different 5711 AeroBar address



NOTE – While on this menu screen and the 5711 AeroBar’s address matches the address shown on the display, all three of the LEDs on the 5711 AeroBar will quickly blink. This allows you to locate the bar that is being addressed. The HHT cannot be used in IR mode to change a bar’s address setting.

BAR ADDRESS
VERI FY
FLASHI NG LEDS
ADDRESS = 0 0

Change the address of the bar, press and hold the <Enter> key for about 5 seconds to activate a “CHANGE ADDRESS” menu screen. Using this screen, an address of 1, 2 or 3 can be set.

CHANGE ADDRESS
Address type
NEW 0
SET: 0

Addresses 1, 2 and 3 are used to denote “independent” bars that will each operate as stand-alone units.

SYSTEM STATUS shows the current status of the 5711 AeroBar:

“**Ionization**” is a short notification of the 5711 AeroBar’s state and will display:

- “ON” when Ionization is normal;
- “SB” when the 5711 AeroBar is in standby;
- “TS” when the 5711 AeroBar is in Alarm Test; or
- “AL” when the 5711 AeroBar has some type of Alarm

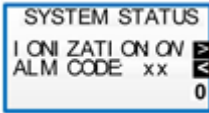

“**ALM Code**” will help diagnose any problems that might occur. All states of the 5711 AeroBar including a normal state have an associated number code (see Table 5. 5711 AeroBar Alarm Codes) to aid in diagnosing any alarms that might occur.

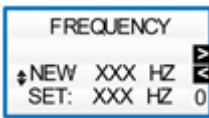

FREQUENCY shows or sets the 5711 AeroBar’s ionization cycle rate, which is the rate at which the ionization changes polarity. By using the <UP> or <Down> arrow keys, you can change the rate at which the ionization polarity changes from 0.1 Hz to 35 Hz. After the value is keyed in, press the <ENTER> key to save the new value in the 5711 AeroBar.

POSITIVE POWER shows or sets the 5711 AeroBar’s positive ionization output level.

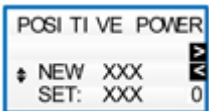

Setting a larger value will increase positive ion production and shift the ion balance in the positive direction. By using the <UP> or <Down> arrow keys you can change the positive ionization level from 1, the minimum power level, to 100, the maximum power level.

NEGATIVE POWER shows or sets the 5711 AeroBar’s negative ionization output level.



Setting a larger value will increase negative ion production and shift the ion balance in the negative direction. By using the <UP> or <Down> arrow keys you can change the negative ionization level from 1, the minimum power level, to 100, the maximum power level.

STANDBY shows or sets the 5711 AeroBar’s Standby mode.

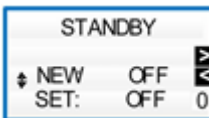

Setting the standby to “ON” will temporarily pause the ionization of the 5711 AeroBar. This state will also be shown in the **SYSTEM STATUS** screen as “SB” with an alarm code of 4.

This screen will also show the state of the standby input request from the MOLEX 4-PIN "SBY/ALM I/ O" port. Note that a standby request from the MOLEX 4-PIN port will override a standby request set using the request of the user.

ALARM TEST activates or deactivates the alarm output.



On this screen, you can turn on or off the alarm circuit to test the FMS connection to your equipment. Pressing the **<Enter>** key will activate the alarm output relay and show a walking  LED display on the 5711 AeroBar. To stop the Test, press the **<Enter>** key again.

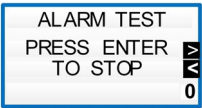

This state will also be shown in the SYSTEM STATUS screen as "TS" with an alarm code of 11.



CAUTION – The Alarm Test will not change the 5711 AeroBar’s ion production. If the ionizer HV is enabled when the Alarm Test is activated, the HV remains enabled during this test.

ATTENTION – Le Test de l’alarme ne change pas le 5711 AeroBar la production d’ions. Si le ioniseur HV est activé lorsque le test de l’alarme est activée, le HV reste activée pendant ce test.

LOAD DEFAULTS to restore settings.

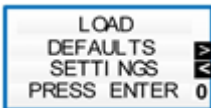

Each 5711 AeroBar contains pre-defined settings that can be recalled to return the 5711 AeroBar to a known operational state.

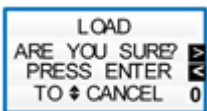

Upon pressing the **<Enter>** key, you must confirm this request. Using the **<Up>** or **<Down>** arrow keys, select either **CANCEL** (default) or **ACCEPT** then press **<Enter>**.

- Selecting ACCEPT will change all the 5711 AeroBar’s settings to the pre-defined values (except the 5711 AeroBar’s address).
- Selecting CANCEL will return you the previous menu screen.



After selecting "**ACCEPT**", the HHT will display "Default Settings Restored" for 2 seconds. The restored settings will take effect immediately.

FIRMWARE VERSION shows the versions of both the 5711 AeroBar and HHT.



Displays the firmware version of the addressed AeroBar (Model 5711) and of the Handheld Terminal (HHT, Model 5700).

Alarms

An alarm condition is indicated by the 5711 AeroBar’s LEDs and the HHT’s red LED (if connected). Alarms are caused by one or more of the following possible conditions:

Code	Grn LED	Yel LED	Red LED	Alarm Contacts	Comments
xx	○	○	○	OPEN	No Power
1	●	○	○	CLOSED	Normal, All OK
2	⊛	○	○	CLOSED	Wire Communication
3	⊛	⊛	○	CLOSED	IR Communication
4	●	●	○	OPEN	Standby Mode
5	●	⊛	○	OPEN	Input Power Warning (<20 VDC)
6	○	○	●	OPEN	Local Power Supply Fault
7	○	○	⊛	OPEN	SLAVE Reporting Fault
8	○	○	●	OPEN	ARC Detected ¹
9	●	●	⊛	OPEN	Broken Wire Detected
10	●	⊛	⊛	OPEN	SLAVE Sync Failure
11		⊛⊛⊛		OPEN	Alarm Test

Off: ○ On: ● ● ● Blink: ⊛ ⊛ ⊛ Walking: ⊛ ⊛ ⊛

Table 5. 5711 AeroBar Alarm Codes

NOTE – The Model 5711 AeroBar does not support the “master/slave bar” configuration, so Alarm codes 7 and 10 do not apply to this product.

“Arc Detected” Alarm

When an ARC is detected at the corona wire emitter cartridge, the AeroBar’s high voltage will turn off for 30 seconds after which the high voltage will turn back on and the AeroBar will resume operation.

Reset Switch (front panel of Controller)

Disconnecting the 5711 AeroBar from the 5711-CTRL Controller while the system is powered up will cause a latched alarm condition (Alarm Code 9 – Broken Wire Detected). To clear this alarm, re-connect the 5711 AeroBar to the powered Controller and either press/release the “Reset” button on the front panel of the Controller or cycle the 24 VDC input power to the system OFF and then back ON again.



CAUTION – For safety, the 5711 AeroBar is designed to shut off the high voltage ionization any time an arc is detected in the area of the corona wire. The Green LED is OFF and the Red LED is ON.

ATTENTION – Pour des raisons de sécurité, les 5711 AeroBar est conçu pour couper la haute tension d’ionisation tout moment un arc est détecté dans la zone du fil corona. Cette alarme est indiqué par un voyant vert allumé et voyant rouge et un état d’alarme .

If the red alarm LED continues to stay lit, contact Simco-Ion Technical Support (techsupport@simco-ion.com or +1 (510) 217-0460).

Alarm Test (for wiring testing, etc.)

The alarm output can be tested without affecting the ionization output. Connect the HHT to the lonizer (see Chapter 2 for more information on connecting the HHT to the 5711 AeroBar.)

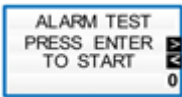

Navigate to the Alarm Test Screen, press the **<Enter>** key on the HHT to start the alarm test.

This will open the Alarm relay contacts, simulating an alarm condition.

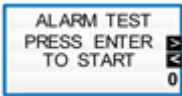

To stop the test and return to normal operation, press the **<Enter>** key on the HHT again.

Standby

Standby allows stopping the flow of ions while keeping the 5711 AeroBar’s electronics power on. This mode can be used to temporarily turn off ionization when there is no product under the bar, thus reducing the contamination build up on the wire.

The 5711 AeroBar can be placed into standby mode by:

- Connecting signal ground to the Standby input on either the controller’s “STANDBY/ALARM” pin 4
- On the HHT, navigate to the Standby screen, and press the up or down arrow keys + **<ENTER>** to set the 5711 AeroBar into standby (“ON”) or normal operation (“OFF”)



NOTE – A standby request via the bar’s “STANDBY/ALARM I/O” connector will override a standby request made via an HHT.

5. MAINTENANCE

As maintenance schedules will vary depending on installation conditions, the end-user will need to develop a schedule that meets the requirements for their application. In general, equipment should be checked monthly to ensure it is operating as originally set.

! **NOTE** – There are no user-serviceable parts inside the 5711 AeroBar nor the 5711-CTRL controller. Any unauthorized service will void the warranty and may result in additional repair charges.

Corona Wire Inspection and Cleaning



CAUTION – Electric Shock Hazard

Remove power from the 5711 AeroBar before inspecting or cleaning the unit.

Do not clean the AeroBar while the unit is powered on. Doing so may result in particle contamination to the work area and electrical shock to the operator.

AVERTISSEMENT – Electric Shock Hazard

Retirer l'alimentation du 5711 AeroBar avant l'inspection ou le nettoyage de l'appareil
Ne pas nettoyer l'AeroBar tandis que l'unité est sous tension. Cela risque d'entraîner la contamination de la zone de travail et d'éventuels chocs électriques à l'opérateur.

Inspection

Before performing any maintenance, the 5711 AeroBar must be powered down.

Dirty or eroded corona wires may result in reduced ionization output or failure. Contamination can be caused by a number of environmental factors, including non-visible airborne molecular contaminants (AMC). The corona wire should be checked regularly for erosion of material accumulating in or around the corona wire and cartridge.

Cleaning

Cleaning is recommended every 6 months or longer depending on the application and/or environment.

Simco-Ion offers a specially designed 5711 AeroBar emitter wire cleaning tool. The tool will conveniently and safely clean the emitter wire using a disposable foam swab wetted with 50% de-ionized water and 50% IPA. See Parts and Accessories for part numbers of the 5711 AeroBar Cleaning Tool, Tool Extension Rod and Emitter Cleaner.



Cleaning the Corona Wire Cartridge Assembly & Chassis



CAUTION – Electric Shock Hazard

Remove power from the 5711 AeroBar before inspecting or cleaning the unit.

Do not clean the AeroBar while the unit is powered on. Doing so may result in particle contamination to the work area and electrical shock to the operator.

AVERTISSEMENT – Electric Shock Hazard

Retirer l'alimentation du 5711 AeroBar avant l'inspection ou le nettoyage de l'appareil

Ne pas nettoyer l'AeroBar tandis que l'unité est sous tension. Cela risque d'entraîner la contamination de la zone de travail et choc éventuel.



CAUTION – Use only 50% de-ionized water and 50% IPA to clean the exterior of the 5711 AeroBar chassis and corona wire cartridge grills. **Do not use any other cleaners or solvents.**

ATTENTION – Utiliser seulement 50 de l'eau déionisée et 50 IPA pour nettoyer l'extérieur du 5711 AeroBar châssis et fil corona cartouche barbecues. **Ne pas utiliser d'autres produits nettoyants ou de solvants.**

The external surfaces of both the 5711 AeroBar chassis and the corona wire cartridge-grill assembly can be cleaned if dirt has accumulated on the surface. Use a cleanroom-compatible cloth moistened with 50% de-ionized water and 50% IPA. Do not use a soaking wet cloth; the cleaning cloth should only be moistened with IPA. Change the cloth frequently to ensure that any dirt is completely removed from the surface to be cleaned. Do not use this method to clean the corona wire inside a cartridge assembly.

Use the recommended Wire Cleaner tool that is described in Chapter 4. After cleaning, allow the bar to dry thoroughly before reapplying power to the bar.

The corona wire cartridge assembly may be cleaned in an ultrasonic bath using deionized water @ 50°C, maximum.



CAUTION – DO NOT ALLOW THE CORONA WIRES TO BE TOUCHED DURING THE WASHING PROCESS.

ATTENTION! NE PAS LAISSER LES FILS CORONA à être touché PENDANT LE PROCESSUS DE LAVAGE.

Care must be taken while loading or removing the corona wire cartridges from the ultrasonic bath.

Cartridges must be loaded into the ultrasonic bath in either a single layer or stacked in a crossed pattern to prevent tangling of the cartridges and damage to the corona wires.

After washing, the cartridges must be completely dry before reinstalling into the bar. The temperature of the drying operation should not exceed 50°C, maximum.

Cartridge Insertion/Removal



CAUTION – Electric Shock Hazard

Remove power from the 5711 AeroBar before inspecting, removing or installing any corona wire cartridges to the bar.

Failure to do so may result in particle contamination to the work area and electrical shock to the operator.

AVERTISSEMENT – Electric Shock Hazard

Retirer l'alimentation du 5711 AeroBar avant d'inspecter, le retrait ou l'installation de tout fil corona cartouches au bar.

Le défaut de le faire peut entraîner la contamination de la zone de travail et d'éventuels chocs électriques à l'opérateur.

Remove power to the 5711 AeroBar before touching the corona wire cartridges.

Remove the Contact Spring Covers

Lift the 5711 uWire end contact spring cover from the end of the cartridge shown below before removing the cartridge from the bar. Pictures below show the end contact spring cover in place and off the bar.

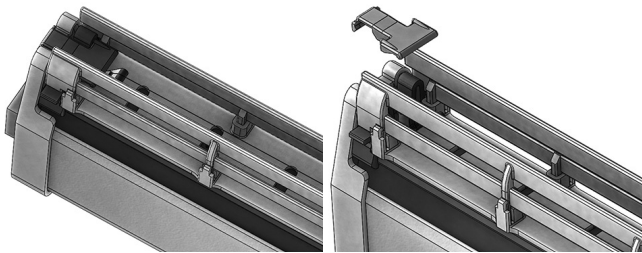

5711 uWire Contact Spring Cover

5711 uWire End Contact Spring
Cover Off Cartridge

Squeeze the release tabs inward on either side of one end of the cartridge and gently pull the end of the cartridge away from the clear retaining clip, angling the cartridge away from the bar. If the other end of the cartridge does not release from its retaining clip as the cartridge angles away, squeeze the release tabs on that clip and gently pull the cartridge out.

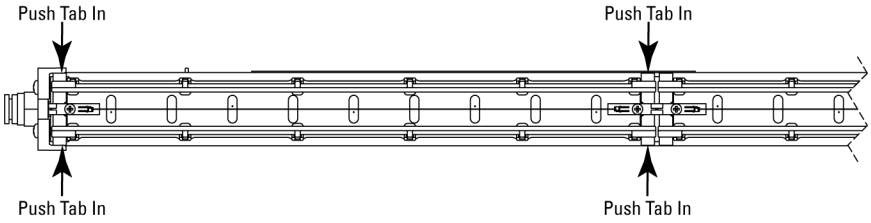

Figure 9. Location of Cartridge Release Tabs on Retaining Clips (top view)

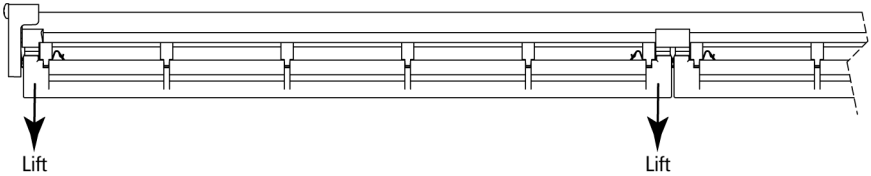









Figure 10. Lift/Pull Cartridge Out of Retaining Clips (side view)

To insert a cartridge, align the cartridge in between the clear retaining clips and gently press the cartridge toward the 5711 AeroBar. The retaining clips should click into place when the cartridge is completely seated. The base plate of the cartridge should be flat against the bar.

Replacement Cartridges

Replacement cartridge assemblies and contact spring covers can be ordered from Simco-Ion. See Parts and Accessories for further information.

6. SPECIFICATIONS

Input Voltage	24 VDC \pm 10%, 12W (max)
Output Voltage	Adjustable, 13 kV pk-pk (typ)
Range	Target ionization 150-2000 mm, application and performance specification dependent
Frequency	Factory default setting is 1 Hz, adjustable from 0.1-35 Hz
Balance	$\leq \pm 25V$ over the length of the bar; maintains balance performance >6 months without cleaning (in an ISO 14644 Class 4 or better environment)
Ion Emission	Micropulsed high voltage technology
Performance	3.5 sec decay average @ 600 mm (typ) measured at 5711 AeroBar center and 25 mm straight air jet spacing, 18 l/m purging air, (250 mm long AeroBar), no laminar flow; setting 1 Hz, 100% output, CPM: balance $\leq \pm 10V$; swing 100V pk-pk
Corona Wire	Tungsten, 80 micron dia.
Gas Supply	Clean dry air (CDA)
Airflow	150 mm AeroBar = 10 lpm, overall per bar; 250 mm AeroBar = 18 lpm, overall per bar (recommended flow is 2 lpm per jet orifice)
Alarm Output	Relay contact, rated ± 24 VDC @ 0.2A max
Cleanroom Class	ISO 14644-1 Class 2 (better than Fed. Std. 209E Class 1)
Operating Env.	Temperature 15-35°C (59-95°F); humidity 30-60% RH, non-condensing
Ozone	<0.05 ppm
EMI	Below background level
Bar Settings	All operating parameters set via a Handheld Terminal (HHT) by either wired connection or by battery powered IR control to the 5711-CTRL Controller
Indicators	Green POWER; Yellow COMMUNICATION; Red ALARM (combinations of LEDs indicate specific status conditions of the bar)
Enclosure	5711 AeroBar: ABS chassis; Stainless steel reference plates 5711-CTRL Controller: Stainless steel chassis
Dimensions	5711 AeroBar Ionizer: 3.0"H x 1.3"W x 6.3 or 10.2"L (76 x 34 x 160 or 260 mm) 5711-CTRL: 4.7"H x 1.9"W x 3.2"D (119 x 48 x 83 mm)
Warranty	Two year warranty
Certifications	   
Power Adapter 14-21328	
Input Voltage	100-240 VAC, 50/60 Hz
Output Voltage	24 VDC, 30 W
Dimensions	3.9"L x 1.4"H x 2.1"W (99 x 36 x 52 mm)
Weight	7 oz (200g)
Certifications	   

Dimension Drawings

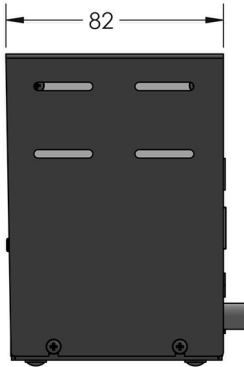
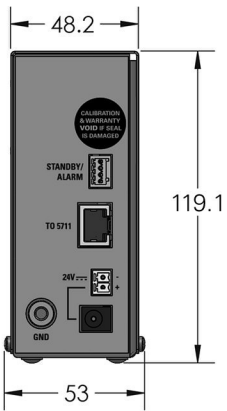
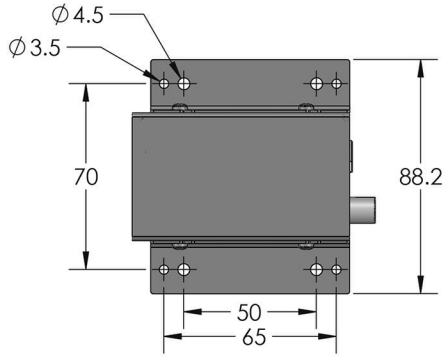

5711-CTRL Controller

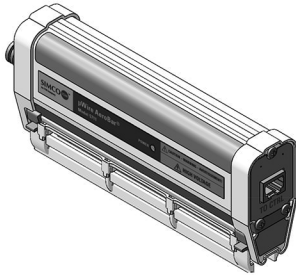
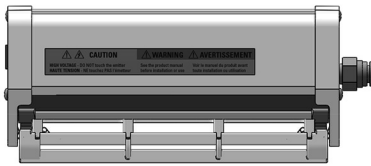
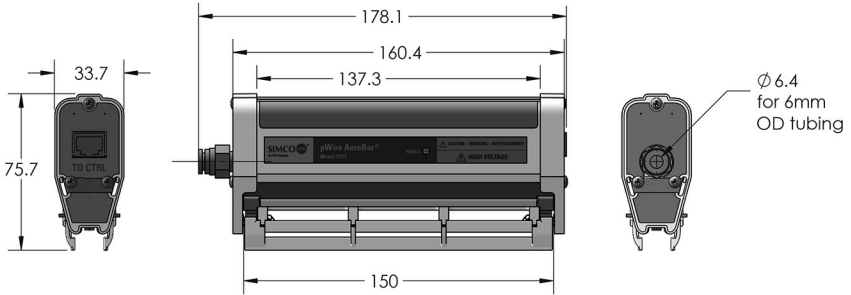
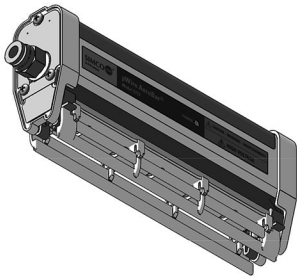

5711-150 mm Bar

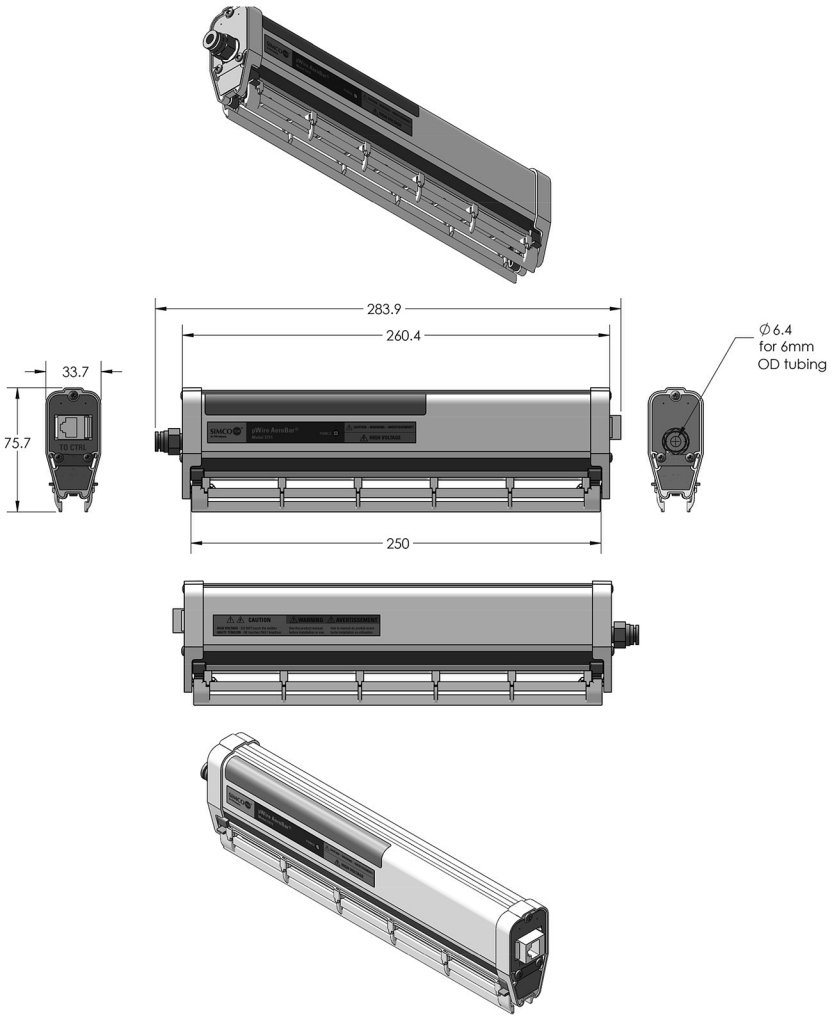

5711-250 mm Bar

Wiring Options

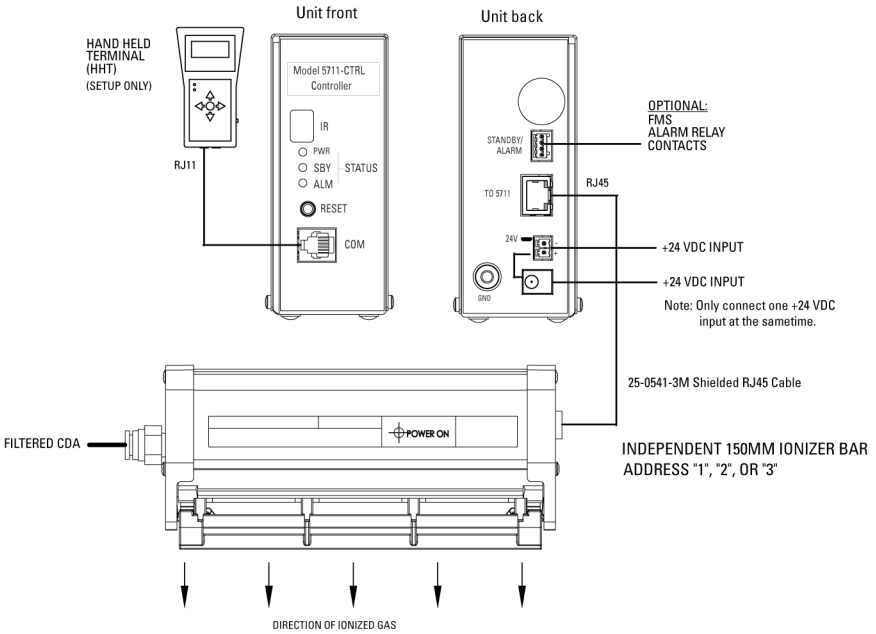

5711-150 mm Bar

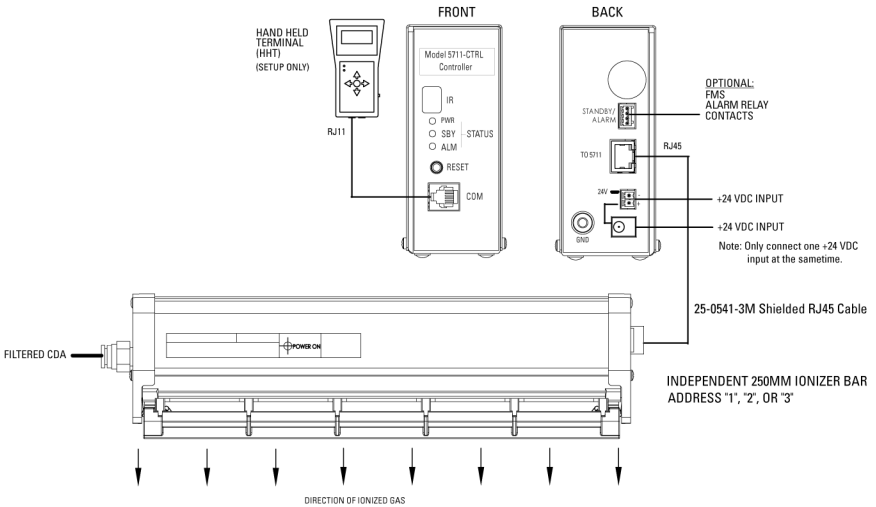

5711-250 mm Bar

Parts & Accessories

Simco-Ion P/N	Description	Item
33-2845-01	Cartridge, 150 mm	
33-2855-01	Cartridge, 250 mm	
33-1710-7 (7 ft)	RJ-11 6 pin, 6 wire power/communication cable	
33-1710-10 (10 ft)		
33-1710-15 (15 ft)		
33-1710-20 (20 ft)		
33-1710-40 (40 ft)		
25-0541-3M	CAT-5 Shielded Ethernet Cable 3m from Controller to Ionizing Bar	
32-2501-01 (incl in 33-2511-01 kit)	4.4 mm single slot (can be inverted)	
32-2503-01 (incl in 33-2513-01 kit)	4.4 mm triple slot (can be inverted)	
32-2502-01 (incl in 33-2512-01 kit)	4.4 mm single slot	
32-2511-01 (incl in 33-2521-01 kit)	4.4 mm single slot (can be inverted)	
32-2510-01 (incl in 33-2520-01 kit)	4.4 mm single slot (can be inverted)	

32-2211-01	Swivel Mounting Bracket	
32-2500-01	M3 thread (increase width to 1"/2.54 cm)	
32-2504-01	4.4 mm double slots (increase width to 1"/2.54 cm)	
32-2213	Mounting Bracket	
32-5713-01	5711-CTRL Controller Mounting Bracket	
91-5700-HHT-01	Handheld Terminal (HHT)	
91-5700-02	Emitter Wire Cleaner with 3 ft. rod (must order 22-1100)	
33-5715-01	Emitter Wire Cleaner 3 ft extension rod	
22-1100	Foam swab, 100 ppi (bag of 100)	
14-21328	DC Power Supply	

Factory Default Settings

The 5711 AeroBar will ship from the factory with the following factory default operating settings. If custom-defined default settings are required, please contact Simco-Ion for further information prior to ordering.

Bar Address: 1 (Independent mode)

Frequency: 1 Hz

Positive Power: 50

Negative Power: 50

Pulse Balance: 0

Standby: OFF

WARRANTY & SERVICE

Simco-Ion provides a limited warranty for the μ Wire AeroBar Model 5711. New products manufactured or sold by Simco-Ion are guaranteed to be free from defects in material or manufacturing for two (2) years from date of initial shipment. Simco-Ion liability under its new product warranty is limited to servicing (evaluating, repairing or replacing) any unit returned to Simco-Ion that has not been subjected to misuse, neglect, lack of routine maintenance, repair, alteration or accident. In no event is Simco-Ion liable for collateral or consequential damages. Consumable items such as, but not exclusive to, emitter points, corona wires, batteries, filters, fuses or light bulbs are only covered under this warranty if found defective as received with the new product.

To obtain service under this warranty, please contact Simco-Ion Technical Support at techsupport@simco-ion.com or +1 510-217-0470.

Customer Service Contact Information

Toll free: +1 (800) 367-2452

salsservices@simco-ion.com

Customer services: +1 (510) 217-0460

techsupport@simco-ion.com

Tech support: +1 (510) 217-0470

www.simco-ion.com

Fax: +1 (510) 217-0484



SIMCO IONTM

An ITW Company

Technology Group

1141 Harbor Bay Pkwy, Ste 201
Alameda, CA USA 94502

Toll free: +1 (800) 367-2452
Sales services: +1 (510) 217-0460
Tech support: +1 (510) 217-0470
Fax: +1 (510) 217-0484

saleservices@simco-ion.com
techsupport@simco-ion.com
www.simco-ion.com